







**3000 ECP
SERIES**

easicodepro

BL3030 ECP (EASICODE PRO)

FEATURES

-  On gate code change
-  1000 hours salt spray tested
-  Designed for metal box section gates
-  Reversible on site
-  Over 1000+ combinations
-  Concealed code change shield



SPECIFICATION

Construction: Cast housing, locking assembly & knob w. S/steel buttons & Locking mechanism

Buttons: 11 button; 9 coded, 1 clear & 1 code change

Finishes: Black marine grade external coating (MG Pro)

Fixings: Forend fixing system and latchbolt to suit profiles 40-60mm

Gate type: Suitable for external metal, box section gates

Inside section: Back to back reversible keypads

PRODUCT DIMENSIONS

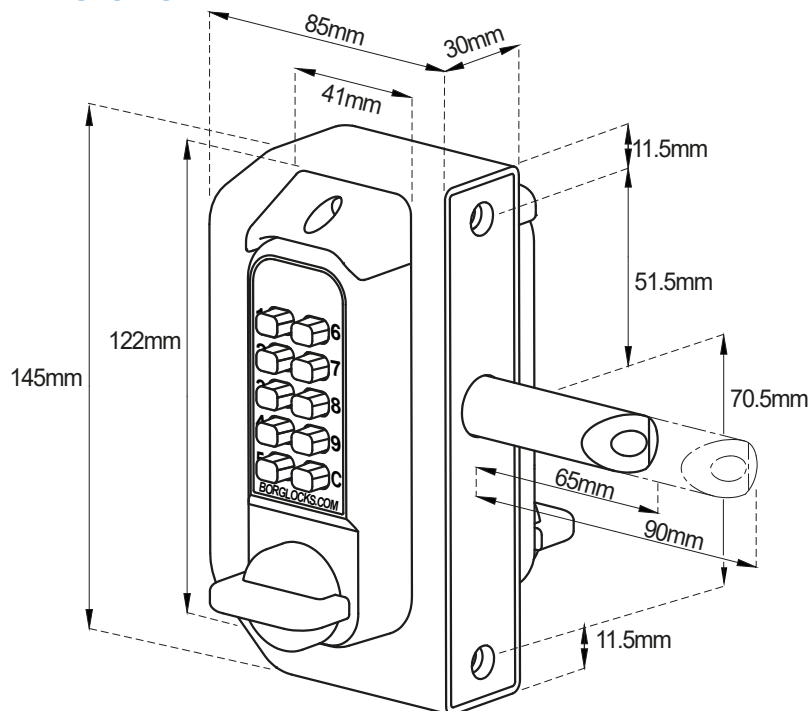

WWW.BORGLOCKS.COM

TEL: 01708 225700

Borg Locks (UK) Ltd Unit 9 Upminster Trading Park, Warley Street, Upminster, Essex RM14 3PJ UK

Borglocks
CONTROLLING ACCESS